

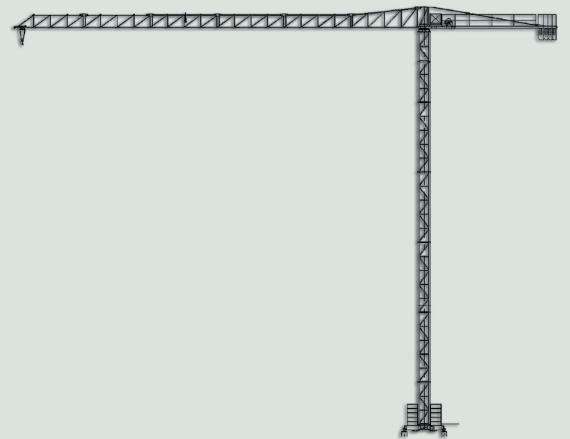



GRD 35

*Gru da città senza cuspidè
Top less city crane
City kran ohne turmspitze
City grue sans poinçon*



RD LIFT

Raggi e portate - Radius and s.w.l.

Portata max / Max s.w.l.	2000 kg.					3000 kg.					
											
Braccio / Jib (m.)	35	28	23	17	12	35	28	23	17	12	
Campo di portata max Max s.w.l. range	18,66	19,88	20,23	15,05	12	13,04	13,80	13,98	13,33	31,02	
Raggi (m.) Radius (m.)	12	2000	2000	2000	2000	2000	3000	3000	3000	3000	3000
	14	2000	2000	2000	2000		2776	2953	2995	2843	
	15	2000	2000	2000	2000		2575	2739	2779	2637	
	16	2000	2000	2000	1870		2399	2553	2590	2458	
	17	2000	2000	2000	1750		2245	2390	2424	2300	
	19	1961	2000	2000			1987	2116	2147		
	20	1855	1987	2000			1878	2000	2030		
	21	1759	1885	1921			1779	1896	1924		
	22	1672	1792	1862			1690	1801	1828		
	23	1593	1707	1740			1609	1715	1740		
	24	1520	1630				1534	1636			
	25	1453	1559				1466	1563			
	26	1392	1493				1403	1496			
	27	1335	1433				1344	1434			
	28	1283	1377				1290	1377			
	29	1234					1240				
	30	1188					1193				
	31	1146					1150				
	32	1106					1109				
	33	1068					1070				
34	1033					1034					
35	1000					1000					



Braccio e contrappeso - Jib and counterweight

Braccio / Jib (m.)	17	23	28.5	35	
Contrappeso / Counterweight (t.)	2,384	3,198	4,012	4,826	
	tipo/ type	Quantità / Quantity			
Composizione / Composition	A 350 (814 Kg.)	-	1	2	3
	B 510 (1192 Kg.)	1	1	1	1















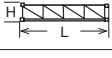



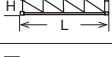

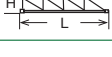

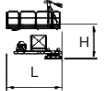

Altezza sottogancio, zavorra di base, reazioni - H.U.H., max base ballast, corner pressure

A			A1			B		
H (m.)	Z (t.)	P max (t.)	H (m.)	Z (t.)	P max (t.)	H (m.)	Z (t.)	P max (t.)
33,2	28	32	-	-	-	32,5	4,2	15,3
29,6	24	24,5	29,6	32	28	28,9	3,7	14,7
23,6	20	19	23,6	28	21	22,9	2,9	13,9
17,6	20	18	17,6	24	18	16,9	0,7	13,1
11,6	20	17	11,6	24	18	10,9	0,5	12,3

Caratteristiche azionamenti principali - General technical characteristics

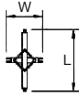
Rotazione - Slewing	giri/min	Kw	cv	Carrello - Trolley	m/min	Kw	cv	Forza motrice totale - Total installed power	
	0,38	2,9	4		20	1,4	2	8,8 Kw (12Hp)	
	0,71				40				
	1,02								
Argano - Hoisting winch	m/min	Kg	Kw	cv	Forza motrice totale - Total installed power				
	5,5	2000	8,8	12	13,1 Kw				
	22	2000							
	44	1000							

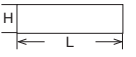
Lista dei pesi - Packing list

Pos. Item	Pezzi Pieces	Descrizione Description	Figura Draw	Dimensioni (m.) Dimensions			Peso (Kg) Weight			
				L	W	H	Unit.	Tot.		
1	1	Elemento di freccia Jib element	N°1 		5,930	0,790	1,930		597	
	1		N°2 		5,985	0,790	1,200		364	
	1		N°3 		11,860	0,790	1,200		330	
	1		N°4 		6,020	0,790	1,200		297	
	1		N°5 		1,700	0,790	1,200		263	
	1		N°6 		1,700	0,790	1,200		238	
2	1	Controfreccia girevole, argano sollevamento, quadro elettrico, cuspide. Counterjib turnable, hoisting winch, trolley jib, electrical bx, a frame.			3,750	1,705	2,300		1925	
	1	Elemento controfreccia esterno. External counterjib.			9,100	0,875	1,230		795	
3	4	Blocchi di contrappeso. Counterweight block.			A350	0,600	0,350	2,145	814	3256
	2				B510	0,600	0,510	2,145	1192	2384
4	1	Elemento di torre Tower element			6,000	1,110	1,110		853	
					3,600	1,110	1,110		521	
5	1	Trave principale di base. Base main beam.			TP (2,8x2,8 m)	4,160	2,400	0,605	-	1083
					TP (3,4x3,4 m)	5,010	2,400	0,605	-	1154
	2	Semitrave di base. Half base beam.			TC (2,8x2,8 m)	1,150	0,300	0,490	172	344
					TC (3,4x3,4 m)	1,575	0,300	0,490	225	450
6	18	Blocco di zavorra Base ballast block (B28-09)			2,800	0,360	0,900	2000	36000	

Sequenza di montaggio - Assembling sequence

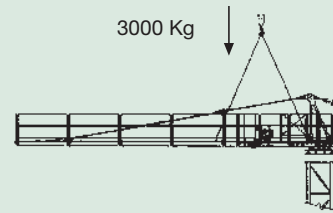
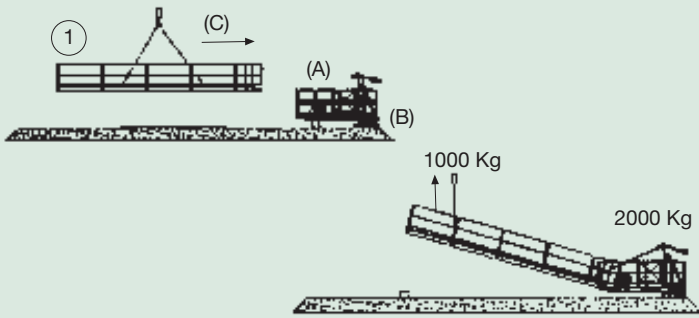
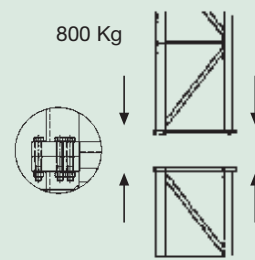
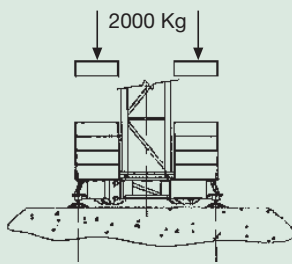
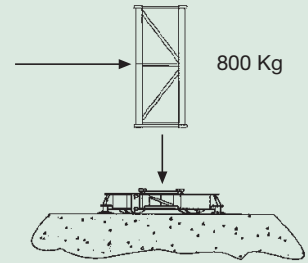
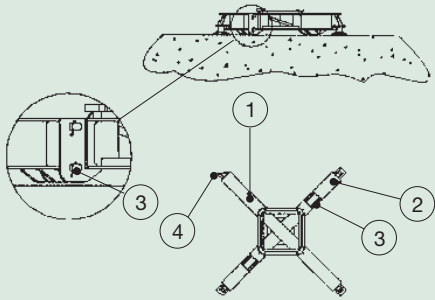



Gru da città senza cuspid
Top less city crane
City kran ohne turmspitze
City grue sans poincon

Dati illustrativi non impegnativi
con riserva di modifica senza
preavviso.

Specifications and data not
binding subject to modification without
notice.

Angaben und Beschreibung
unverbindlich andreungen
vorbehalten ohne weitere mitteilung.

Données techniques seulement
indicatives modifications réservées
sans préavis

RDLIFT

RDLIFT srl

Via Emilia San Pietro, 25

42100 Reggio Emilia – Italy

Tel. +39 0522 448511 - Fax +39 0522 448540

commerciale@rdlift.com

www.rdlift.com

Agente - Dealer