





Gru automatica idraulica SMH 400

Triverter 444



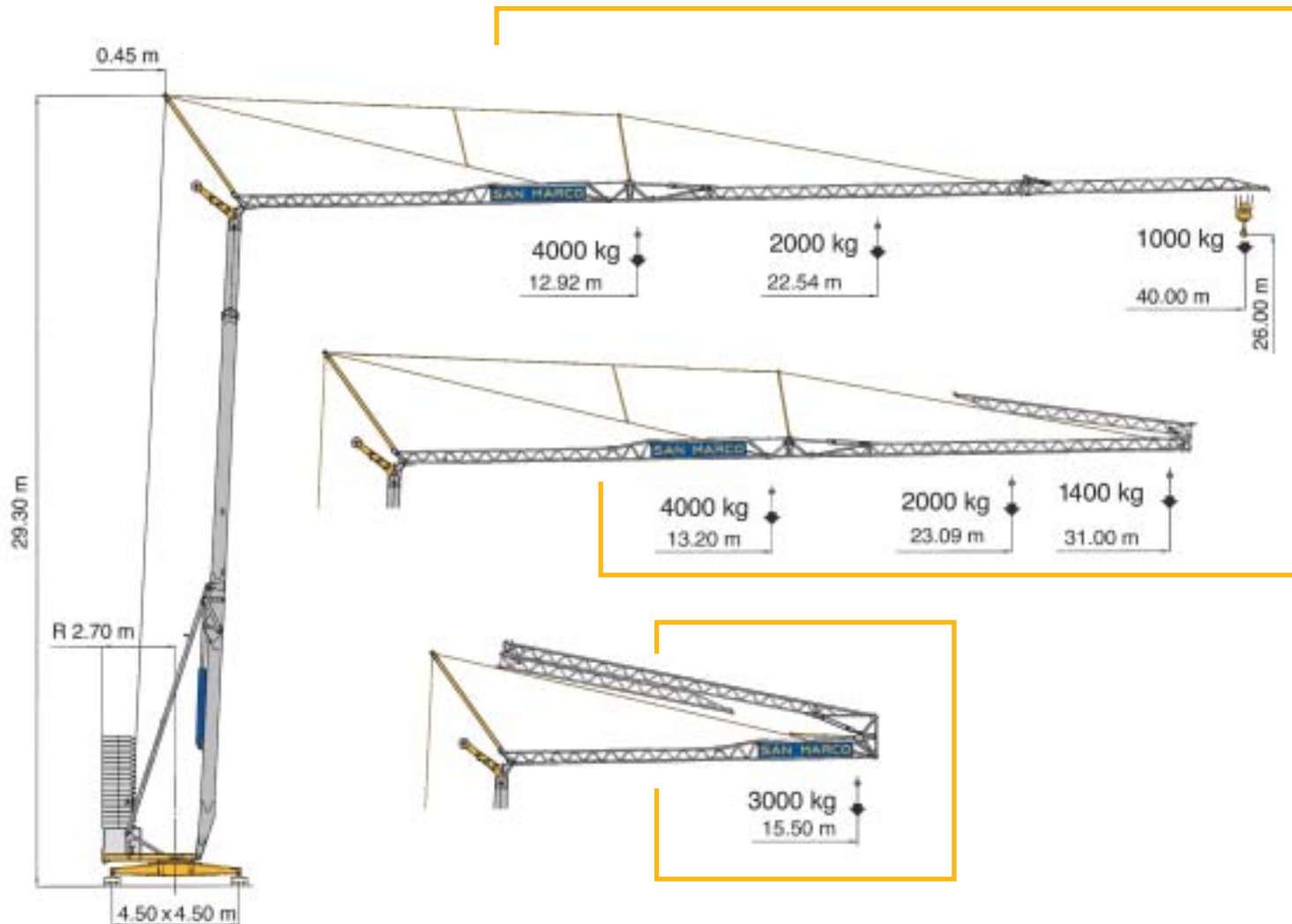

-  Automatic crane hydraulic
-  Automatischer Hydraulischer Kran
-  Grue automatique hydraulique
-  Grua automatica hidraulica



DIN 15018 H1 B3
ISO 4301



Montaggio

-  Erection
-  Montage
-  Montage
-  Montaje

kW	4
----	---

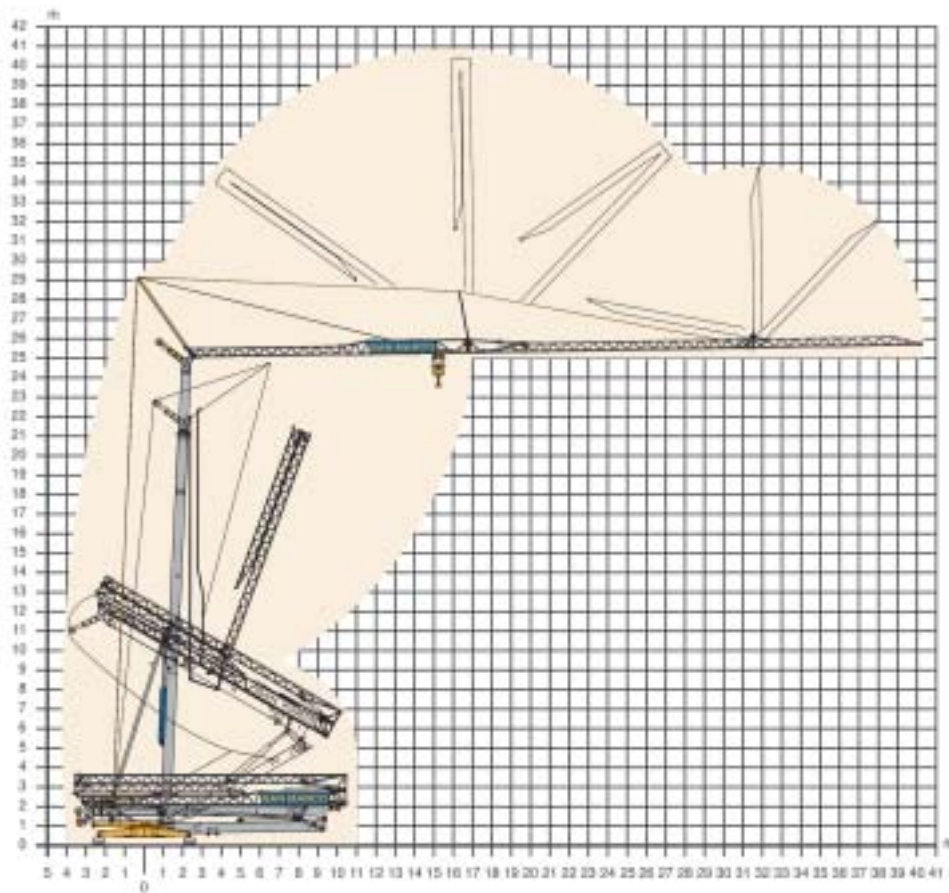

Diagrammi di carico

-  Loads diagrams
-  Lastkurven
-  Courbes de charges
-  Curvas de carga

Braccio impennato
Inclined jib
Schräggestellter Ausleger
Fleche relevée
Flecha inclinada



Carrello traslante
Traversing trolley
Verfahrbare laufkatze
Chariot distributeur
Carro distribuidor

 Kg	40
800	39.60 m





Braccio orizzontale
Horizontal Jib
Fleche horizontale
Waagerechter Ausleger
Flecha horizontal



Freccia chiusa
Closed Jib
Auslegerspitze zu
Fleche fermée
Flecha plegada

 Kg	40	31	15.50
4000	12.92 m	13.20 m	
3000	16.21 m	16.58 m	15.50 m
2000	22.54 m	23.09 m	
1800	24.59 m	25.19 m	
1600	27.10 m	27.76 m	
1400	30.24 m	31.00 m	
1200	34.32 m		
1000	40.00 m		

Reazioni (F) e pesi (P)

-  Reactions (F) - Loads (P)
-  Eckdrücke (F) - Krangewicht (P)
-  Réactions (F) - Poids (P)
-  Reacciones (F) - Pesos (P)

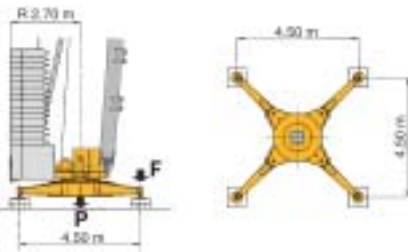

F	P
35 t	49 t

In servizio • In service
In Betrieb • En service
En servicio

F	P
21 t	45 t

Fuori servizio • Out of service
Ausser Betrieb • Hors service
Fuera de servicio

Gru automatica idraulica SMH 400

Triverter 444

Potenza elettrica necessaria

- Power requirement
- Anschlusswert
- Puissance électrique nécessaire
- Potencia eléctrica necesaria

kW	20
----	----

Alimentazione elettrica

- Mains supply
- Netzstrom
- Réseau électrique
- Alimentación eléctrica

V	380 (±5%)
Hz	50

Carrello - Variatore (Inverter)

- Trolley - Speed controller
- Katzfahren - Unrichter
- Chariot - Variateur
- Carro - Variador

m/min	10	20	30	40
kW	1.8			

Sollevamento - Variatore (Inverter)

- Hoisting - Speed controller
- Heben - Unrichter
- Levage - Variateur
- Elevación - Variador

m/min	12	25	38	50	6	12	19	25
kg	2000	2000	1400	1000	4000	4000	2800	2000
kW	8.8				8.8			

Rotazione - Variatore (Inverter)

- Slewing - Speed controller
- Schwenken - Unrichter
- Orientation - Variateur
- Orientación - Variador

rpm	0.1	0.3	0.5	0.9
kW	3			

Trasporto

- Transportation
- Transport
- Transport
- Transporte

	P1 3300 kg	P2 16700 kg
	P1 + P2 20000 kg	

Con assali senza zavorra • With axles without ballast • Mit transportachse ohne Ballast • Avec essieux sans lest • Con ejes sin contrapeso

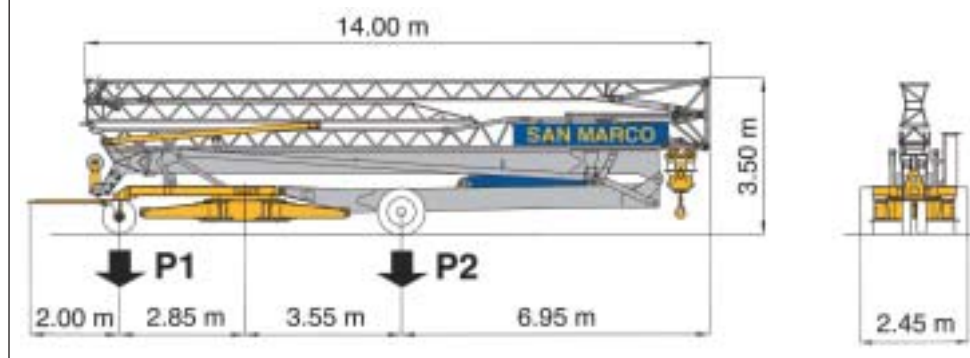

Anemometro

- Anemometer
- Windmesser
- Anemometre
- Anemometro

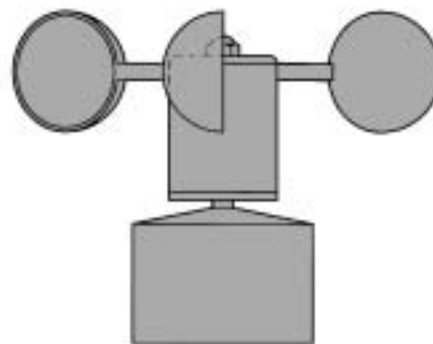

segnalatore ottico
segnalatore acustico
campo di regolazione:
01 km/h - 250 km/h

visual danger signal
auditory danger signal
control field:
01 km/h - 250 km/h

optischer Gefahrensignale
akustischer Gefahrensignale
Verwendungsbereich:
01 km/h - 250 km/h





signau visual
signau auditif
champ d'emploi:
01 km/h - 250 km/h

señalador optico
señalador acustico
campo de regulacion:
01 km/h - 250 km/h

- media/grande velocità sollevamento • medium/major hoisting speed • mittel/große Hubgeschwindigkeit • moyenne/grande vitesse de levage • velocidad media/gran velocidad elevacion
- media/grande velocità rotazione • medium/major rotation speed • mittel/große Drehgeschwindigkeit • moyenne/grande vitesse orientation • velocidad media/gran velocidad giro
- media/grande velocità carrello • medium/major trolley speed • mittel/große Katzgeschwindigkeit • moyenne/grande vitesse chariot • velocidad media/gran velocidad carro

- lontano sbraccio (sx) - vicino sbraccio (dx) • distant jib (sx) - near jib (dx) • Ausladung fern (sx) - Ausladung nah (dx) • flèche lointain (sx) - flèche proche (dx) • carro punta (sx) - carro torre (dx)
- salita sollevamento (sx) - discesa sollevamento (dx) • load block up (sx) - load block down (dx) • Heben Hebevorgang (sx) - Senken Hebevorgang (dx) • montée levage (sx) - descente levage (dx) • subida de gancho (sx) - bajada de gancho (dx)
- rotazione sinistra (sx) - rotazione destra (dx) • left rotation (sx) - right rotation (dx) • Drehung links (sx) - Drehung rechts (dx) • orientation gauche (sx) - orientation droite (dx) • giro izquierda (sx) - giro derecha (dx)

Le gru San Marco

-  San Marco Cranes
-  San Marco Kräne
-  Les grues San Marco
-  Las gruas San Marco

SMH Gru automatica idraulica
Automatic crane hydraulic
Automatischer Hydraulischer Kran
Grue automatique hydraulique
Grua automatica hidraulica

SMT Gru a torre montaggio modulare
Tower crane modular assembly
Turmdrehkran modulare montage
Grue a tour montage modulaire
Grua torre montaje modular

		L (m)																									
		12	14	18	20	22	24	25	26	27	28	30	32	34	36	38	40	42	44	45	46	48	50	52	55		
SMT	42																										
	42																										
	42																										
	42																										
	42																										
	42																										
	42																										
	42																										
	42																										
	42																										
SMH	28																										
	26																										
	23																										
	22																										
	22																										
	19,5																										
	18																										
	16,5																										
	16,5																										
	16,5																										
14																											

Strutture in acciaio ad alta resilienza per impiego a basse temperature • Zincatura torre e braccio con immersione a caldo secondo ISO 1461 • Bassa emissione acustica e livello di potenza sonora garantito e certificato • Climatizzazione termostatica dell'equipaggiamento elettrico per alte e basse temperature • Dispositivi di autolivellamento e autozavorramento • Mezzi di accesso alla parte superiore della gru a posizionamento programmabile e equipaggiamento di sicurezza.

 High resilience steel structures to be used at low temperature • Galvanised tower and jib with hot dipping in conformity ISO 1461 • Guaranteed and certified low acoustics emission and sound powers level • Automatic temperature control of electrical equipment for high and low temperatures • Full automatic devices for self levelling and ballast loader • Disassembled stair on the tower with security device.

 Strukturen aus besonders schlagfesten Stahl für den Einsatz bei niedrigen Temperaturen • Turm und Ausleger lt. ISO 1461 heißverzinkt • Niedriger Geräuschpegel und Schallleistungsniveau garantiert und zertifiziert • Thermostatgesteuerte Klimatisierung der elektrischen Ausrüstung für hohe und niedrige Temperaturen • Vorrichtungen zur Selbstnivellierung und Selbstballastierung • Ausrüstungen für den Zugang zum oberen Teil des Krans mit programmierbarer Positionierung und Sicherheitsvorrichtung.

 Charpente en acier à haute résilience pour utilisation en température ambiante froide • Galvanisation à chaud mat et flèche par immersion selon ISO 1461 • Émission acoustique réduite et niveau de puissance sonore garantie avec certificat • Climatisation thermostatique de l'équipement électrique pour températures ambiante élevées ou basses • Dispositifs automatiques de mise a niveau et de lestage • Escaliers d'accès au mat démonatables avec dispositif de protection.

 Estructura en acero de alta resistencia para uso a baja temperaturas • Zincado en caliente de la torre y flecha según normativa ISO 1461 • Baja emisión acústica y nivel de potencia sonora garantizada y certificada • Climatización termostática del equipamiento eléctrico para bajas y altas temperaturas • Dispositivos de autonivelamiento y auto cargado del lastre • Medios de acceso a la parte superior de la grúa con posicionamiento programable y equipos de seguridad.

- Conforme alle direttive CEE: 89/392; 91/368; 93/44; 93/68 e 98/37 direttiva macchine
- Conforme alle direttive CEE: 2000/14 e 87/405 livello acustico
- Conforme alle direttive CEE: 89/336 compatibilità magnetica
- Conforme alle direttive CEE: 73/23 bassa tensione
- Conforme al D.P.R. 27/4/55 n. 547
- Le nostre macchine sono protette da assicurazione per responsabilità civile prodotti senza termine
- Specifiche suscettibili di variazioni senza preavviso.

-  • In compliance with the EEC 89/392; 91/368; 93/44; 93/68 and 98/37 regulations
- In compliance with the EEC 2000/14 and 87/405 regulations on noise levels
 - In compliance with the EEC 89/336 regulations on electromagnetic compatibility
 - In compliance with the EEC 73/23 regulations on electrical equipment
 - Machine covered by lifetime public liability insurance coverage
 - Specifications subject to modification without notice.

-  • Gemäss EWG Richtlinien 89/392; 91/368; 93/44; 93/68 und 98/37
- Gemäss EWG Richtlinien 2000/14 und 87/405 über schall-leistungspegel
 - Gemäss EWG Richtlinie 89/336 über Elektromagnetische Verträglichkeit
 - Gemäss EWG Richtlinie 73/23 über Elektrische Ausrüstung
 - Maschine unter Produkt-Haftpflichtversicherungsschutz ohne Fristangabe
 - Obiges kann ohne Berstaendigung geaendert werden.

-  • Conforme à les directives CEE 89/392; 91/368; 93/44; 93/68 et 98/37
- Conforme à les directives CEE 2000/14 et 87/405 sur le niveau acoustique
 - Conforme à la directive CEE 89/336 sur la compatibilité électromagnétique
 - Conforme à la directive CEE 73/23 sur l'équipement électrique
 - Machines assurées pour la responsabilité civile des produit sans échéance
 - Specifications susceptibles de modification sans avis préalable.

-  • Conforme con las directivas CEE 89/392; 91/368; 93/44; 93/68 y 98/37
- Conforme con las directivas CEE 2000/14 y 87/405 sobre el nivel acustico
 - Conforme con la directiva CEE 89/336 sobre la compatibilidad magnetica
 - Conforme con la directiva CEE 73/23 sobre baja tension
 - Máquina protegida y asegurada por la responsabilidad civil de productos todo riesgo
 - Especificaciones sujetas a modificaciones sin previo aviso.



SAN MARCO
INTERNATIONAL
COSTRUZIONI GRU - BETONIERE
E ATTREZZATURE EDILI

SAN MARCO INTERNATIONAL s.r.l.
via Principe Umberto, 42/B - 28021 Borgomanero (No) Italy
tel. +39 0322 82601 (4 linee r.a.) - fax +39 0322 846035
www.sanmarco-int.com sanmarco@sanmarco-int.com

