

- S1200 - 1.20x1.20 m
- S1700 - 1.70x1.70 m

Torre/Reazioni - Masts/Reactions - Mat/Réactions - Maste/Eckdrücke - Mástil/Reacciones - Tramo/Reacções

S1200

 15 m  $\longrightarrow$  52.5 m

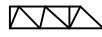
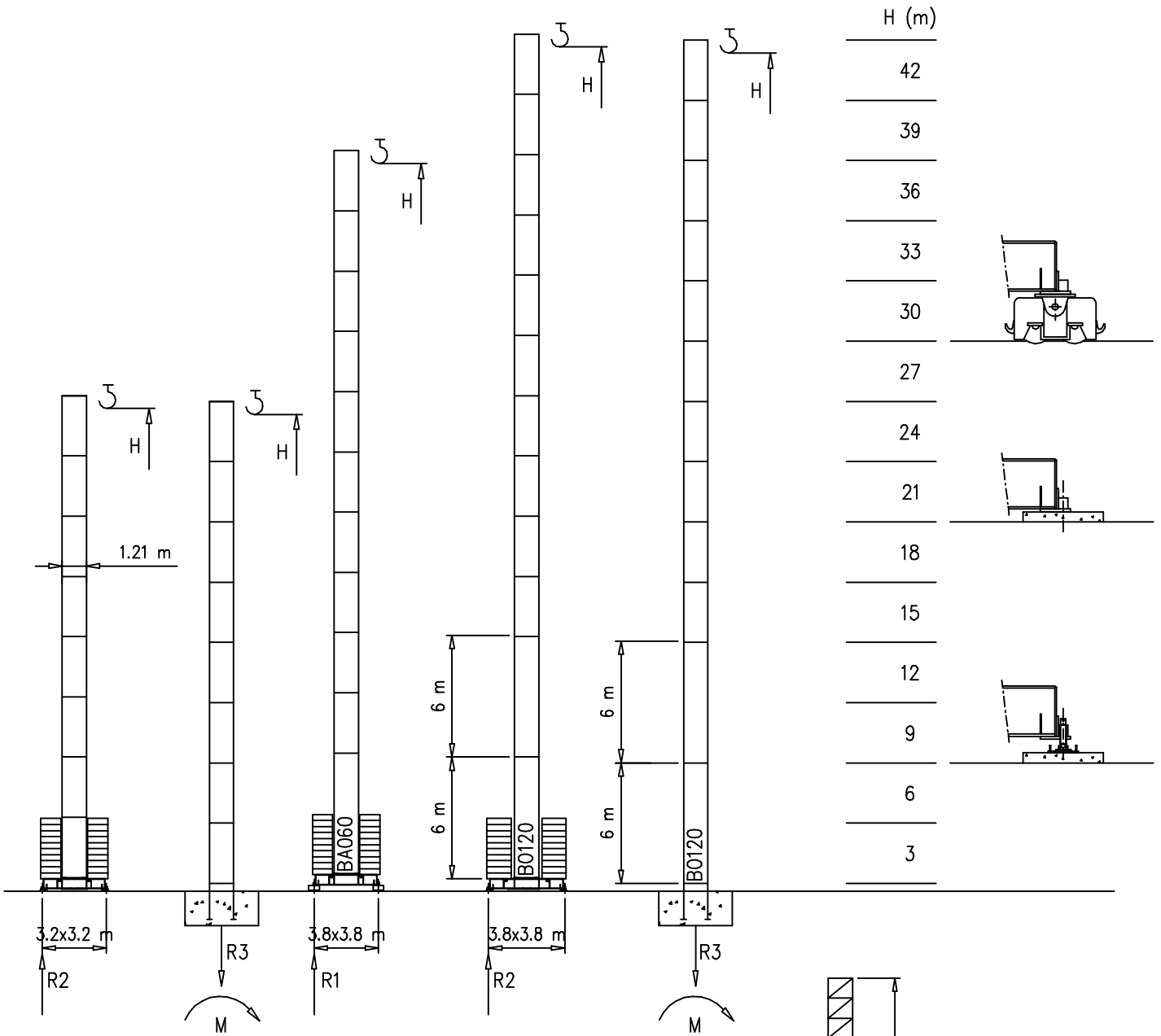

H=37-42 m		H=24-36 m		H=0-23 m	
R1		R1	53 t	R1	49 t
R2	69 t	R2	53 t	R2	47 t
R3	40 t	R3	25.6 t	R3	22 t
M	185 tm	M	116 tm	M	80 tm

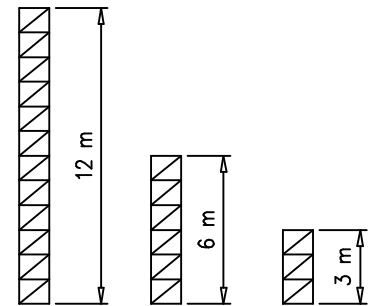

Peso zavorra - Ballast weight - Poids du lest - Ballastgewicht - Peso de lastre

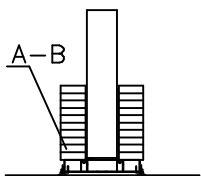

H	n°	Tot.
0-24 m	18 B	54000 kg
25-36 m	20 B	60000 kg
37-42 m	24 B	72000 kg

	A	B
L	3.6m	4.0m
k	0.3m	1.2m
d	1.15m	0.19m

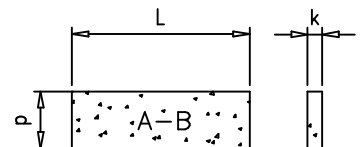

Torre/Reazioni – Masts/Reactions – Mat/Réactions – Maste/Eckdrücke – Mástil/Reacciones – Tramo/Reacções

S1700

 15 m → 52.5 m

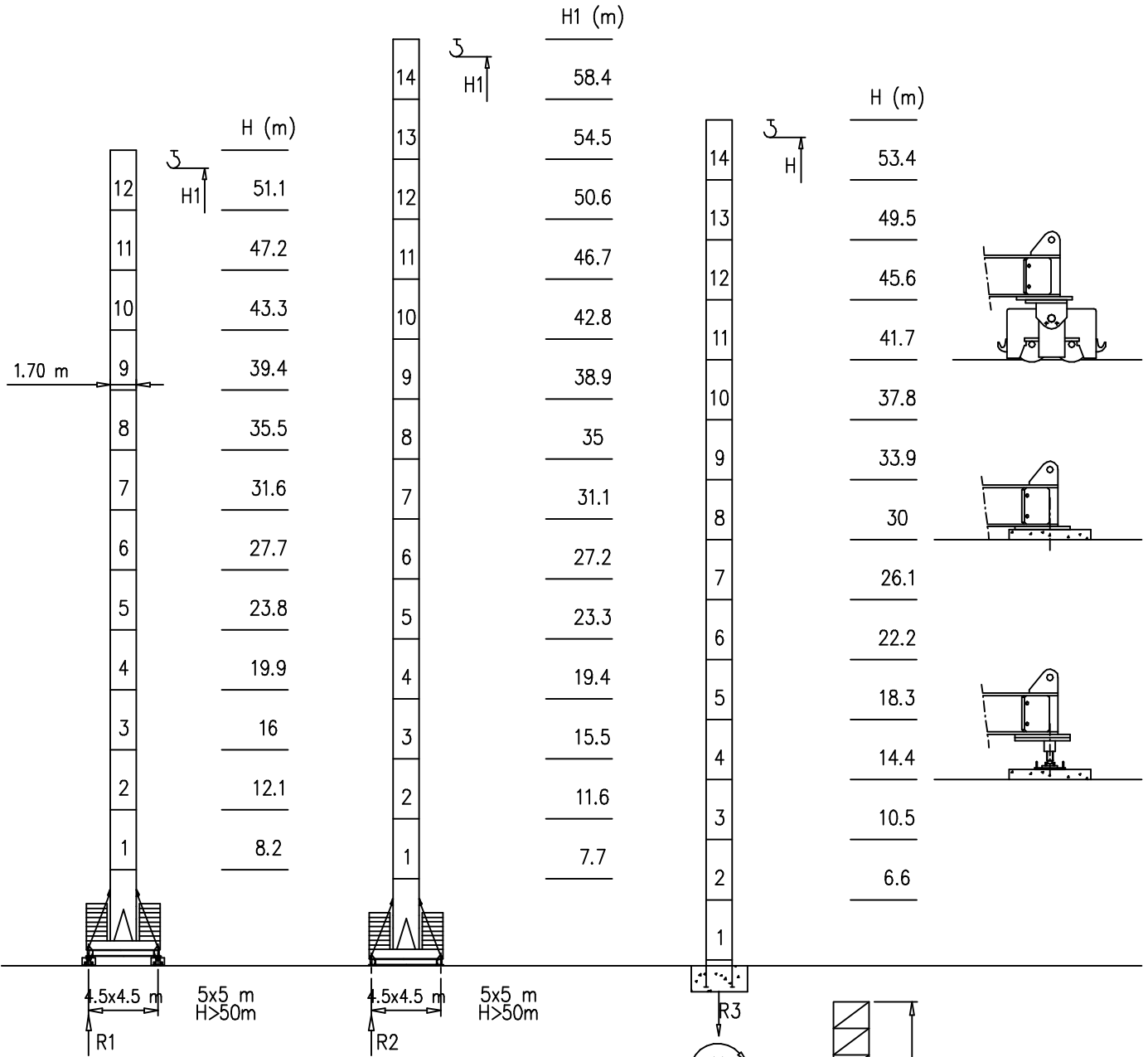

H=46–58 m		H=36–45 m		H=0–35 m	
R1	106 t	R1	72 t	R1	65 t
R2	106 t	R2	72 t	R2	65 t
R3	95 t	R3	61 t	R3	54 t
M	336 tm	M	194 tm	M	156 tm

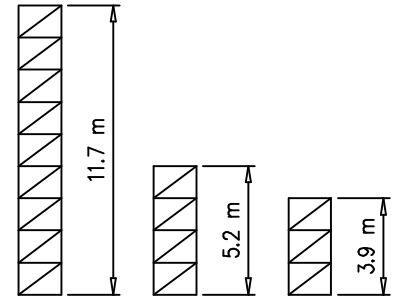





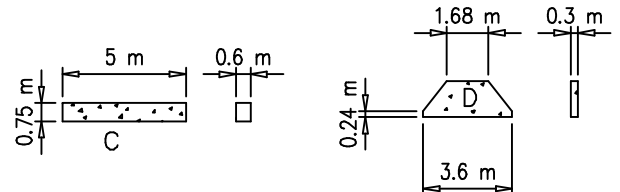













Peso zavorra – Ballast weight – Poids du lest – Ballastgewicht – Peso de lastre

H	n°	Tot.
0–35 m	2C+ 18D	60800 kg
36–45 m	2C+ 22D	72000 kg
46–58 m	2C+ 34D	105550 kg





















Curve di carico – Courbes de charges – Load diagrams – LastKurven – Curvas de cargas

Pmax 3000 kg

	14400 kg		52.5 m	2	24.5	25	27.5	30	32.5	35	37.5	40	42.5	45	47.5	50	52.5	m
				3000	3000	2950	2650	2370	2150	1970	1810	1660	1530	1420	1310	1220	1000	kg
	14400 kg		50 m	2		27.5	30	32.5	35	37.5	40	42.5	45	47.5	50			m
				3000		3000	2700	2450	2230	2040	1875	1730	1600	1485	1300			kg
	12000 kg		45 m	2			29	32.5	35	37.5	40	42.5	45					m
				3000			3000	2600	2370	2170	2000	1820	1600					kg
	10800 kg		40 m	2			30	32.5	35	37.5	40							m
				3000			3000	2790	2540	2250	2000							kg
	10800 kg		35 m	2				32.5	35									m
				3000				3000	2600									kg
	9600 kg		30 m	2				30										m
				3000				3000										kg
	8400 kg		25 m	2			25											m
				3000			3000											kg
	7200 kg		20 m	2			20											m
				3000			3000											kg
	4800 kg		15 m	2			15											m
				3000			3000											kg



Pmax 6000/3000 kg

	14400 kg		52.5 m	2	13	15	17.5	20	22.5	25	27.5	30	32.5	35	37.5	40	42.5	45	47.5	50	52.5	m
				6000	6000	5300	4450	3840	3300	2950	2650	2370	2150	1970	1810	1660	1530	1420	1310	1220	1000	kg
	14400 kg		50 m	2		15	17.5	20	22.5	25	27.5	30	32.5	35	37.5	40	42.5	45	47.5	50		m
				6000		6000	5075	4350	3810	3360	3000	2700	2450	2230	2040	1875	1730	1600	1485	1300		kg
	12000 kg		45 m	2		16	17.5	20	22.5	25	27.5	30	32.5	35	37.5	40	42.5	45				m
				6000		6000	5350	4600	4050	3550	3190	2870	2600	2370	2170	2000	1820	1600				kg
	10800 kg		40 m	2		17	20	22.5	25	27.5	30	32.5	35	37.5	40							m
				6000		6000	4900	4300	3800	3410	3070	2790	2540	2250	2000							kg
	10800 kg		35 m	2		18	20	22.5	25	27.5	30	32.5	35									m
				6000		6000	5380	4720	4180	3750	3380	3000	2600									kg
	9600 kg		30 m	2		19	20	22.5	25	27.5	30											m
				6000		6000	5690	4990	4430	3800	3300											kg
	8400 kg		25 m	2			20	22.5	25													m
				6000			6000	5280	4300													kg
	7200 kg		20 m	2			17	20														m
				6000			6000	4500														kg
	4800 kg		15 m	2		12	15															m
				6000		6000	4500															kg



Montaggio – Montage – Erection – Montage – Montaje – Montagem

X (m)	kg
3,2x3,2	2300kg
3,8x3,8	4500kg
4,5x4,5	3800kg





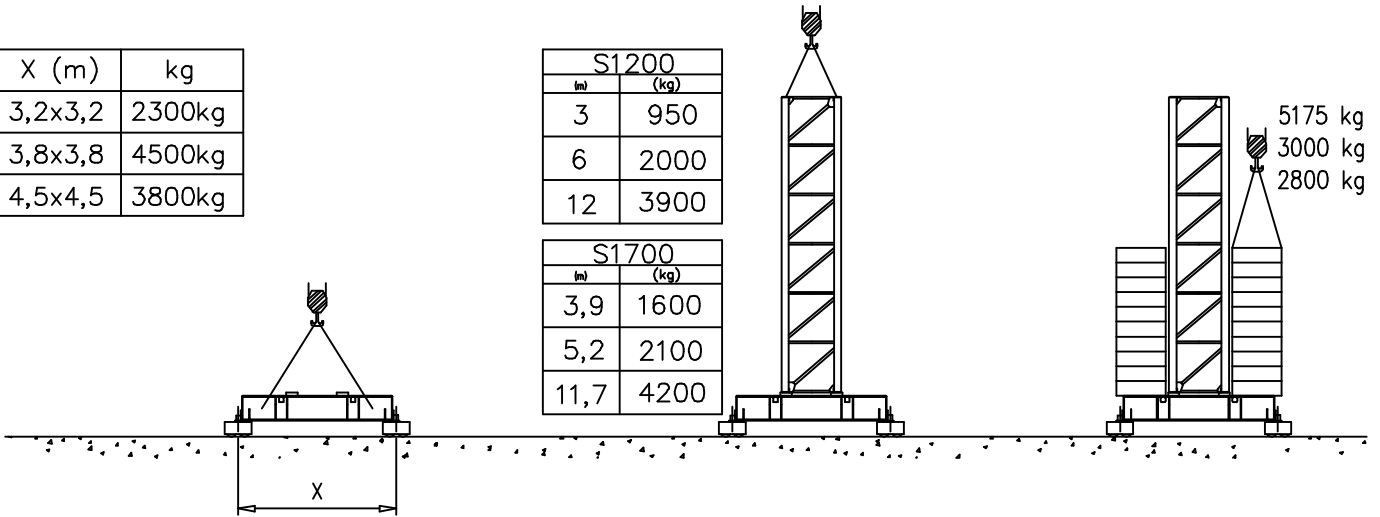



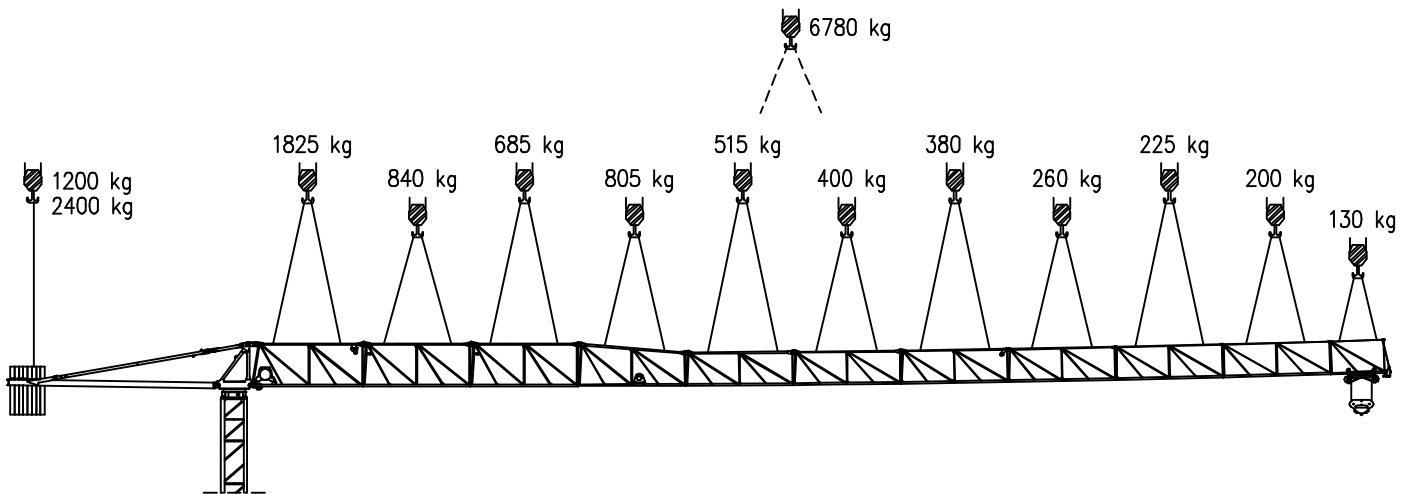
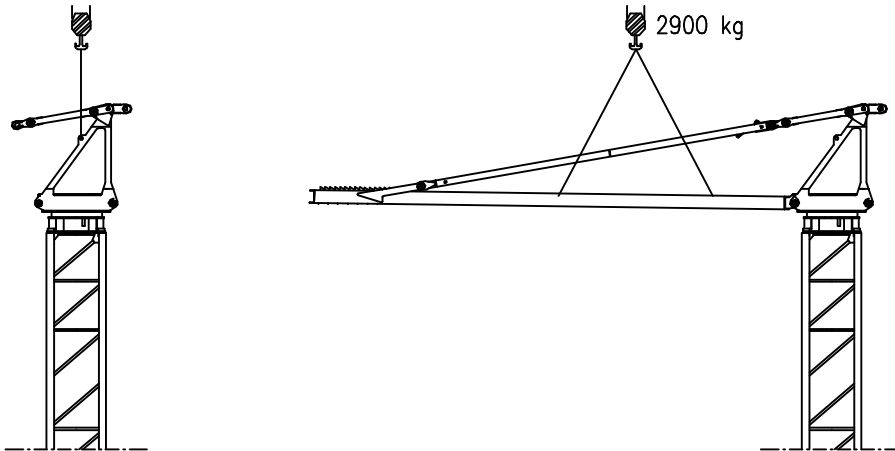

S1200	
ln	(kg)
3	950
6	2000
12	3900

S1700	
ln	(kg)
3,9	1600
5,2	2100
11,7	4200



Torre	kg
S1700	5000 kg
S1200	3500 kg

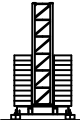

Sollevamento V25.60 Hoisting Levage Heben Elevaciòn Elevaçao			1a	7 m/min	3000 kg	18.5 kW	V25.60 33 kVA					
			2a	18 m/min	3000 kg							
			3a	28 m/min	3000 kg							
			4a	42 m/min	2250 kg							
			5a	56 m/min	1500 kg							
			1a	3.5 m/min	6000 kg							
			2a	9 m/min	6000 kg							
			3a	14 m/min	6000 kg							
			4a	21 m/min	4500 kg							
			5a	28 m/min	3000 kg							
Sollevamento V33.90 Hoisting Levage Heben Elevaciòn Elevaçao			1a	3 m/min	3000 kg	22 kW	V33.90 42 kVA					
			2a	18 m/min	3000 kg							
			3a	34 m/min	3000 kg							
			4a	54 m/min	1800 kg							
			5a	70 m/min	1300 kg							
			6a	90 m/min	500 kg							
			1a	1.5 m/min	6000 kg							
			2a	9 m/min	6000 kg							
			3a	17 m/min	6000 kg							
			4a	27 m/min	3600 kg							
			5a	35 m/min	2600 kg							
			6a	45 m/min	1000 kg							
			Carrello Trolleying Distribution Katzfahren Distribuciòn Distribuição					1a	OP 5 m/min	6000 kg	3 kW	Potenza elettrica necessaria Puissance électrique nécessaire Necessary electric power Anschlusswert – Potencia
								2a	25 m/min	6000 kg		
3a	50 m/min	3000 kg										
Rotazione Slewing Orientation Schwenken Orientaciòn Rotaçao			1a	0 → 0.2	giri/min tr/min rp/min	4.4 kW @ 1200rpm n* 2 x 2.2 kW						
			2a	0 → 0.6								
			3a	0 → 0.9								
Traslazione Travelling Translation Kranfahren Traslaciòn Traslacão			1a	OP 0 → 5	3.7 kW							
			2a	0 → 20								

Rete elettrica – Réseau – Mains supply – Netzstrom – Red – Rede electrica 400V – 50 Hz

**AFM Gru** FMgru s.r.l.  
via Emilia 11-29010 Pontenure PC ITALY  
tel. 0523/510446 ric.aut. fax 0523/510365  
www.fmgru.com e-mail: info@fmgru.com

FEM 1.001  
2000/14/CE



Documento commerciale non contrattuale  
Per tutte le informazioni tecniche riferirsi  
alle corrispondenti istruzioni

Unverbindliches Vertriebsdokument.  
Für technische Informationen, siehe die  
entsprechenden Anweisungen.

This commercial document is not legally  
binding. For any technical information, please  
refer to the corresponding instructions.

Documento comercial no contractual  
Para cualquier información técnica,  
ver la noticia correspondiente.

Code: 15ICA37T30A0			
Ed.	Data	Rev	Data
1	10.01.07	1	18.12.07